

FEATURES

- Plastic package has Underwriters Laboratory Flammability Classification 94V-0
- Fast switching for high efficiency
- Low forward voltage drop
- Single rectifier construction
- High surge capability
- For use in low voltage ,high frequency inverters, free wheeling ,and polarity protection applications
- High temperature soldering guaranteed:260°C/10 seconds, 0.25"(6.35mm)from case
- Component in accordance to RoHS 2011/65/EU

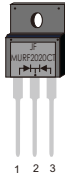

ITO-220AB

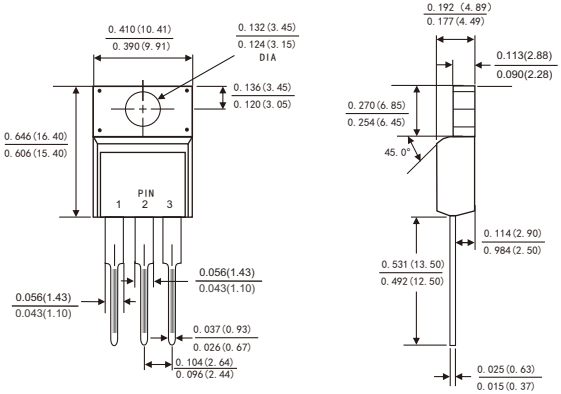

MECHANICAL DATA

- Case: JEDEC ITO-220AB molded plastic body
- Terminals: Lead solderable per MIL-STD-750,method 2026
- Polarity: As marked.
- Mounting Position: Any

Dimensions in inches and (millimeters)

MAXIMUM RATINGS AND ELECTRICAL CHARACTERISTICS

(Ratings at 25°C ambient temperature unless otherwise specified ,Single phase ,half wave ,resistive or inductive load. For capacitive load,derate by 20%.)

Parameters	Symbols	MURF 2020CT	MURF 2040CT	MURF 2060CT	Units
Maximum repetitive peak reverse voltage	V_{RRM}	200	400	600	Volts
Maximum RMS voltage	V_{RMS}	140	280	420	Volts
Maximum DC blocking voltage	V_{DC}	200	400	600	Volts
Maximum average forward rectified current(see Fig.1)	Per leg	10.0	20.0		Amps
	Total device				
Peak forward surge current 8.3ms single half sine-wave superimposed on rated load (JEDEC method)	I_{FSM}	150			Amps
Maximum instantaneous forward voltage at 10.0 A per leg(Note 1)	V_F	0.975	1.3	1.5	Volts
Maximum instantaneous reverse current at rated DC blocking voltage(Note 1)	$T_a=25^{\circ}C$	5			μA
	$T_a=125^{\circ}C$	50			
Maximum Reverse Recovery Time (Note 2)	T_{rr}	35			ns
Typical thermal resistance (Note 3)	$R_{\theta JC}$	4.5			$^{\circ}C/W$
Operating junction temperature range	T_J	-55 to+150			$^{\circ}C$
Storage temperature range	T_{STG}	-55 to+150			$^{\circ}C$

- Notes:**
1. Pulse test: 300 μs pulse width,1% duty cycle
 2. Reverse recovery test conditions $I_F=0.5A,I_R=1.0A,I_{rr}=0.5A$
 3. Thermal resistance from junction to case

RATINGS AND CHARACTERISTIC CURVES OF MURF2020CT THRU MURF2060CT

FIG.1-FORWARD CURRENT DERATING CURVE

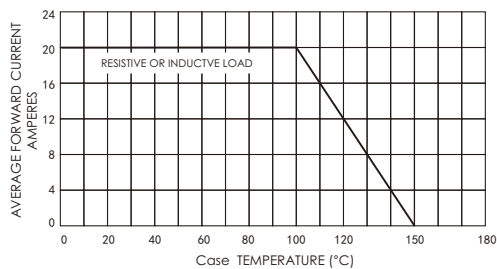

FIG.2-MAXIMUM NON-REPETITIVE PEAK FORWARD SURGE CURRENT

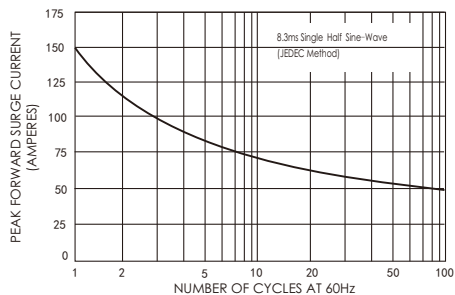

FIG.3-TYPICAL INSTANTANEOUS FORWARD CHARACTERISTICS

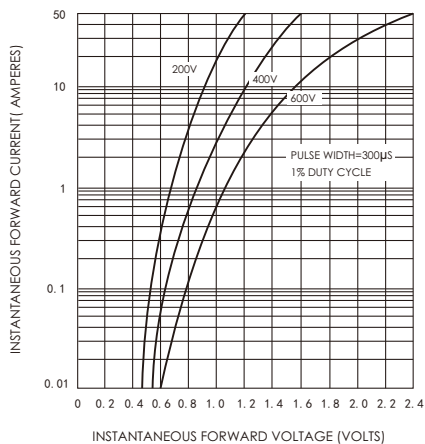

FIG.4-TYPICAL REVERSE CHARACTERISTICS

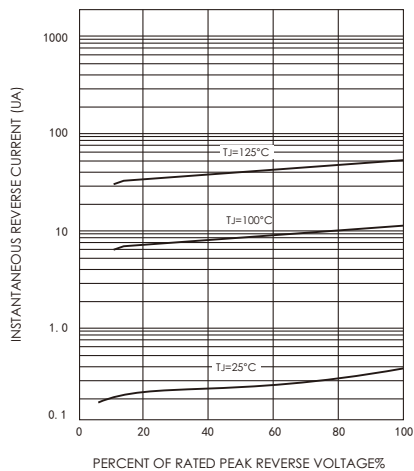

FIG.5-TYPICAL JUNCTION CAPACITANCE

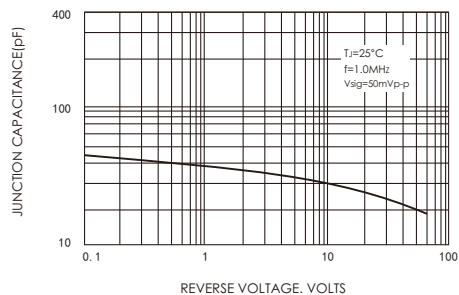

FIG.6-TYPICAL TRANSIENT THERMAL IMPEDANCE

